



Spatial Light Modulators LCOS-SLM

Applications and Features (Laser processing / marking, etc.)

CONTENTS

P.2	Structure / Specifications	P.12	Image gallery
P.4	Technologies	P.13	Features
P.5	Applications	P.15	Related product
P.10	LCOS-SLM for material processing laser	P.15	FAQ
P.10	Damage type	P.17	Related thesis / Technical materials
P.11	Results of laser irradiation		

Structure / Specifications

The LCOS-SLM X15213 series is a reflective liquid crystal device that can control the wavefront of light with high efficiency and high precision by phase modulation.

It consists of a head and a controller connected by a flexible cable.

► Structure

■ Head

Type no.	Number of pixels	Pixel pitch (μm)	Effective area size (mm)	Fill factor (%)	Weight (g)
X15213 series	1272 × 1024	12.5	15.9 × 12.8	96.8	152 (Water cooled type: 552) (Sapphire type :557)

■ Controller

Type no.	Supply voltage AC (V)	Power supply frequency (Hz)	Weight		Input signal	DVI signal format (pixels)	Input signal level (levels)	DVI frame rate (Hz)	Power consumption (W)
			Main unit (g)	Including cable (g)					
X15213 series	100 to 230	50/60	910	1350	DVI-D/ USB-B (2.0 High-speed)	1280 × 1024	256	60	15

- X15213 series

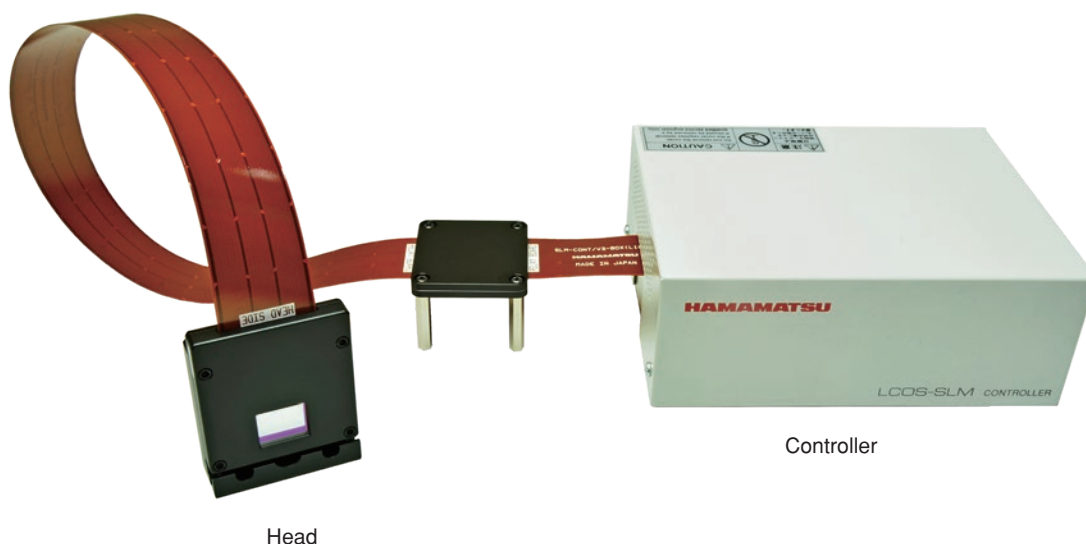

Head

Controller

Outline

The X15213 series offers an extensive lineup to meet the needs of various wavelengths. All types have a glass substrate with an anti-reflection coating and a CMOS chip with a mirror. Recommended beam diameter ($1/e^2$) is 8 mm or more.

●Aluminum mirror type (-01/-07/-08)

The aluminum mirror type uses the reflection from the aluminum electrode on the CMOS chip and has a wide reflection band, so it can be used in a wide wavelength range.

●Dielectric multilayer mirror type (-02/-03B/-05/-12/-13/-15/-16/-19)

The dielectric multilayer mirror type has a specially designed dielectric multilayer film on the surface of the CMOS chip to support laser light sources of various wavelengths. Compared to the aluminum mirror type, the higher reflectivity achieved by the dielectric mirror decreases the internal absorption rate. High light utilization efficiency can be realized.

●Water-cooled type (-02L/-02R/-03BL/-03BR/-12L/-12R/-15L/-15R/-16L/-16R/-19L/-19R)

The dielectric multilayer mirror type head with a built-in water-cooled heat sink suppresses temperature rise due to laser irradiation and achieves high power handling capability. Particularly, the nice power handling capability of -03BL/-03BR enables to be used with high power lasers up to average 200 W at 1050 nm wavelength.

●Sapphire type (-03CL/-03CR)

In addition to the water-cooled heat sink, the glass substrate is made of sapphire glass, which has approximately 30 times higher thermal conductivity than conventional materials. As a result, the heat dissipation efficiency has been improved. Furthermore, we have succeeded in increasing the power handling capability of 700 W or more by enclosing high-thermal conductivity fillers inside LCOS-SLM packaging and optimizing the internal construction. It is possible to respond to high-power lasers required for metal processing.

Spectral response

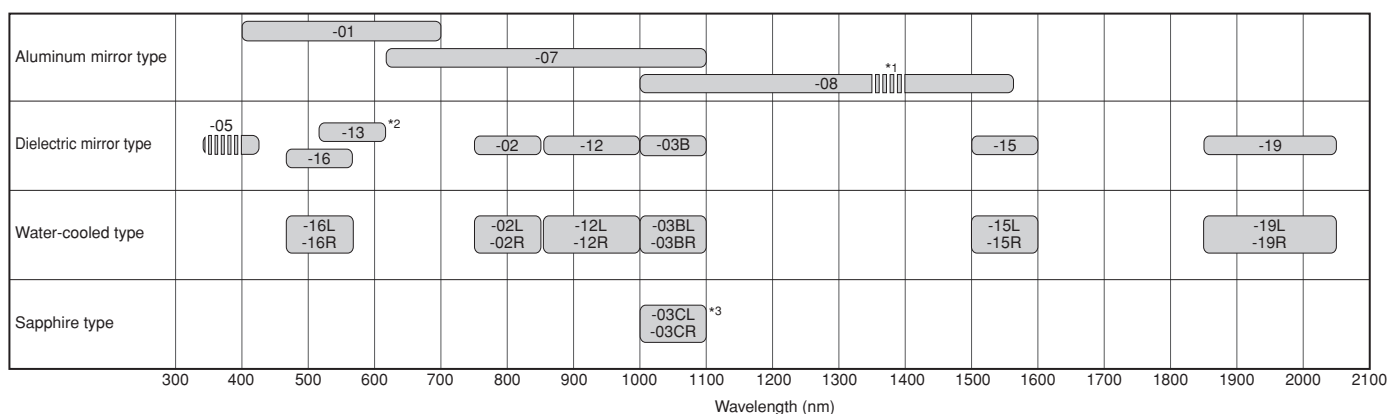

*1 -08: In the wavelength range of 1350 nm to 1400 nm, absorption by the glass substrate reduces reflectance by approximately 5%.

*2 -13 and -16: They can be used for 532 nm band lasers. The -16 has higher power handling capability for short pulse lasers than the -13.

*3 -03CL/-03CR: They have a very high power handling capability of over 700 W and are suitable for metal processing.

Electric and optical characteristics

Type no.	Readout light wavelength (nm)	Light utilization efficiency typ. (%)	Rise time*1 typ. (ms)	Fall time*1 typ. (ms)
X15213-01	400 to 700	76	5	21
X15213-02/-02L/-02R	800 ± 50	97	33	85
X15213-03B/-03BL/-03BR /-03CL/-03CR	1050 ± 50	97	27	83
X15213-05	410 ± 10	97	7	17
X15213-07	620 to 1100	80	9	73
X15213-08	1000 to 1550	86	13	145
X15213-12/-12L/-12R	850 to 1000	97	38	109
X15213-13	530 to 635	97	10	21
X15213-15/-15L/-15R	1550 ± 50	97	26	135
X15213-16/-16L/-16R	510 ± 50	97	11	33
X15213-19/-19L/-19R	1850 to 2050	97 ²	30 ²	155 ²

*1 Time required to change from 10 % to 90 % for 2π modulation.

*2 Design value for a laser with an oscillation wavelength of 1950 nm.

* Lasers with the following wavelengths are used to measure light utilization efficiency, rise time, and fall time.

Laser emission wavelength 633 nm (X15213-01)

Laser emission wavelength 785 nm (X15213-02 series)

Laser emission wavelength 1064 nm (X15213-03B series/-07)

Laser emission wavelength 405 nm (X15213-05)

Laser emission wavelength 1550 nm (X15213-08/-15 series)

Laser emission wavelength 940 nm (X15213-12 series)

Laser emission wavelength 532 nm (X15213-13/-16 series)

Technologies

▶ Optical beam shaping technology

Unlike conventional intensity modulation techniques using masks to block out light to form a desired optical pattern, the LCOS-SLM redistributes the light to generate light patterns efficiently by using phase type holograms.

■ Optical system

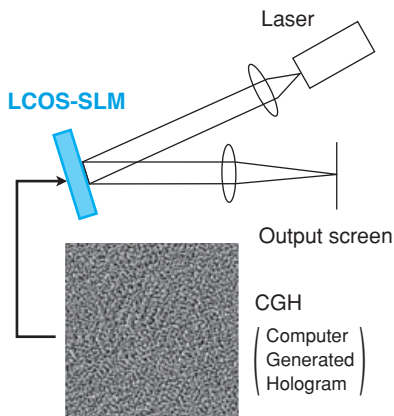

○ High efficiency achieved through maskless design.



2D code reconstructed image with 0th order light suppression

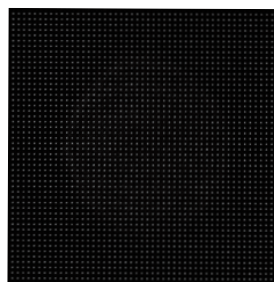

Multi-point generation (50x50) with 0th order light suppression



Example of character reconstruction

▶ Aberration correction technology

Imaging performance is degraded largely by aberrations that are wavefront distortions on any kind of optical system. In a microscope, the aberrations cause lower resolution and contrast, and in laser processing, they cause lower processing quality and efficiency, for example. An optimum optical system can be achieved by controlling the wavefront to cancel its distortion.

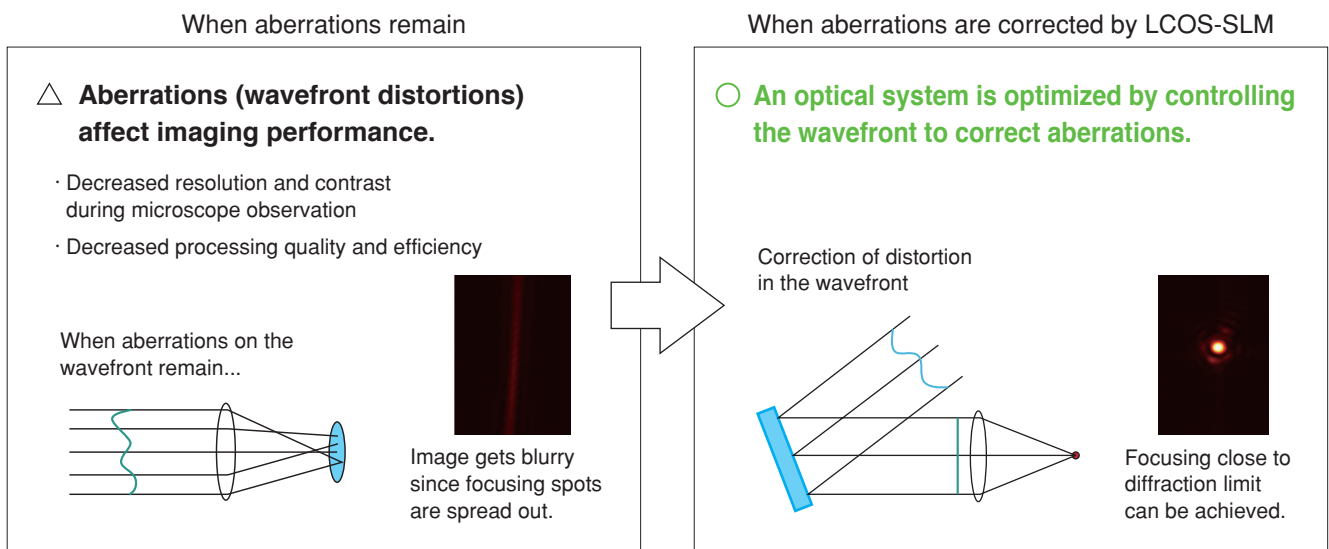

Applications

► Multi-point laser material processing

Simultaneous processing with holographic beam-shaping technology

Optical pattern forming technology allows generating multiple laser beams, so high throughput can be achieved by simultaneous multi-point processing. Furthermore, an unprecedented laser processing can be realized by controlling the 3D space including the depth rather than just the 2D plane.

- High speed by multi-point processing
- Depth controllable
- Simultaneous aberration correction

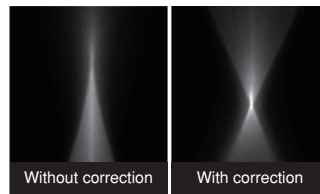

Lateral view of focusing beams

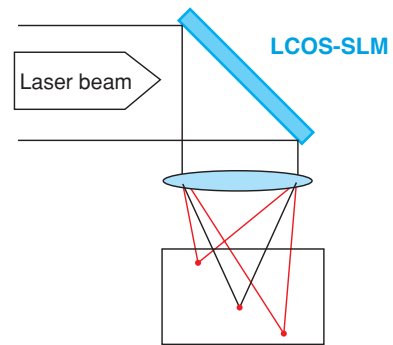

* Joint research with Kyoto University and New Glass Forum in NEDO project

► Super-fine multi-point simultaneous laser processing with multiple beam interferometer

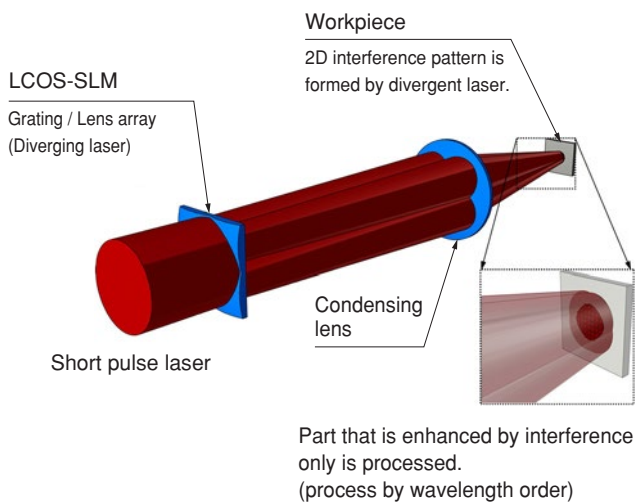

■ Processing examples

ITO layer removal

Laser: Picosecond laser SHG 515 nm

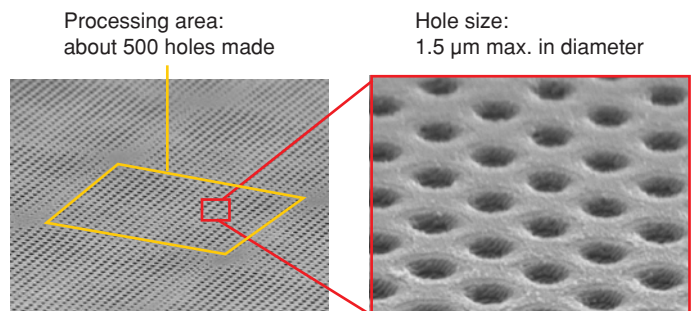

► Optical vortex generation

Optical vortex can be generated with a spiral phase distribution modulated by an LCOS-SLM.

■ Optical system

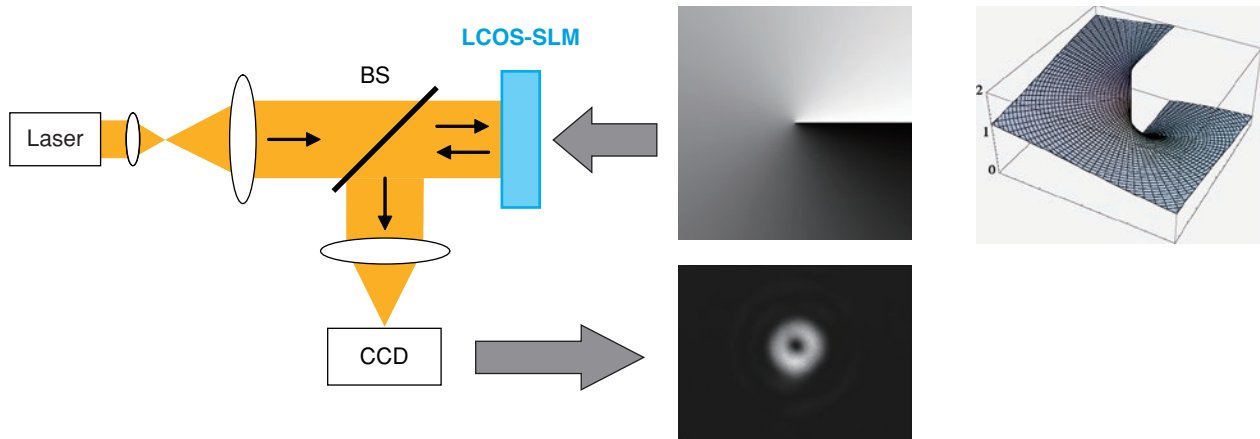

■ Result of high order beam generation

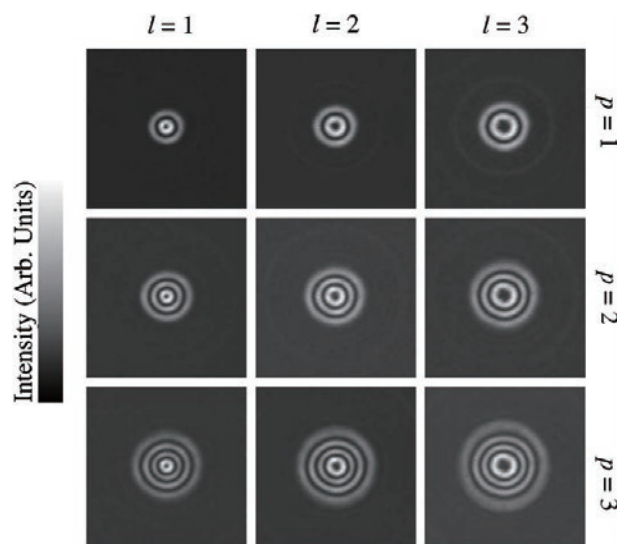

■ Related thesis

- Structure of optical singularities in coaxial superpositions of Laguerre-Gaussian modes
Journal of the Optical Society of America A
Vol. 20 No. 2 (2013)133-138

► Fundus imaging system using adaptive optics

Dynamically eliminates human eye aberrations for high-resolution ocular fundus imaging.

• Visual cells can be discerned

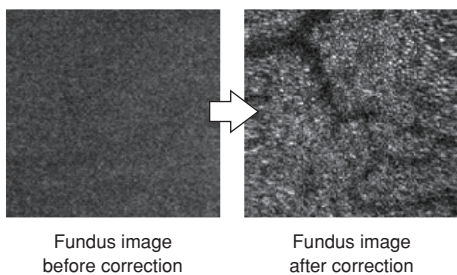

* Under joint development with NIDEK in NEDO project

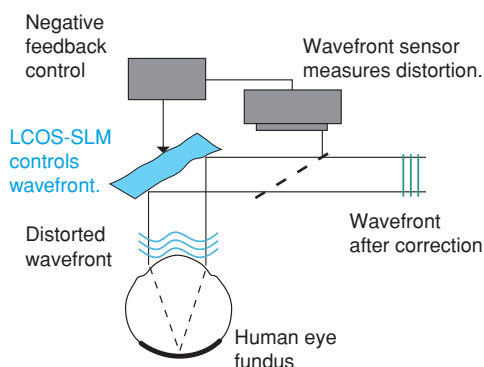

■ Experimental example of dynamic wavefront correction

Improvement with adaptive optics

- Beam size <math>< 1/25</math>
- Peak intensity > 12 times
- PV value > 10 λ (Peak to Valley)

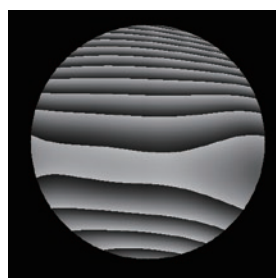
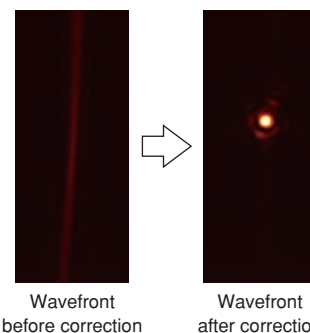

Aberration

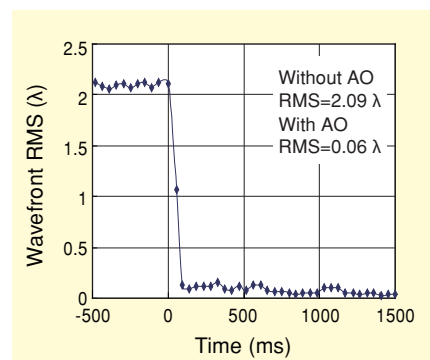

► Optical manipulation (optical tweezers)

Wavefront control for efficient and precise manipulation

Technology for trapping microscopic objects by optical pressure

Biology and science fields need equipment able to handle microscopic objects in large quantities with high precision.

- Multi-point control
- 3D control
- Beam shape control

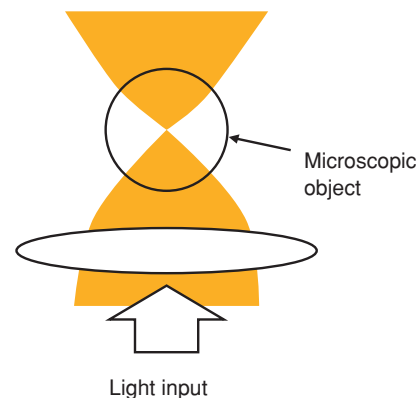
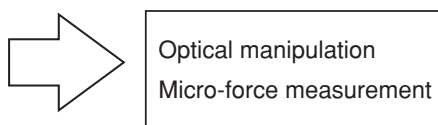

► Beam control: lens function and non-diffractive beam generation

Various beams can be generated and controlled by displaying phase images for lens functions, Bessel beam generation, etc. in the LCOS-SLM, which is expected to be applied to cutting-edge applications such as light sheet microscope, etc.

■ Cylindrical lens functions

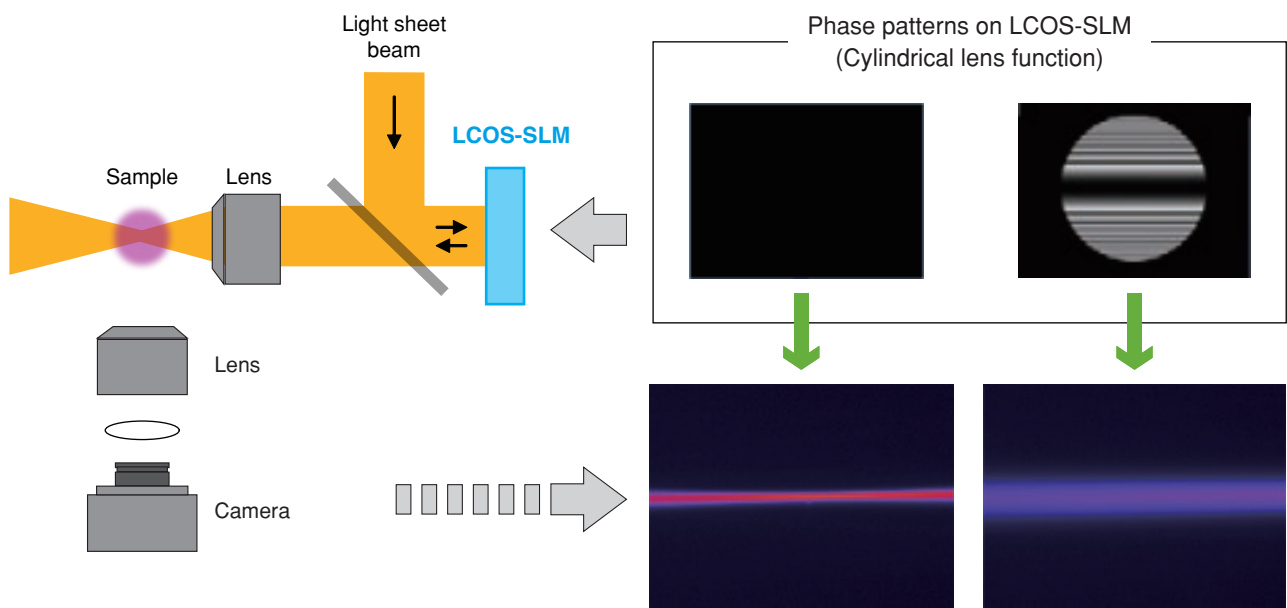

■ Non-diffractive beam generation

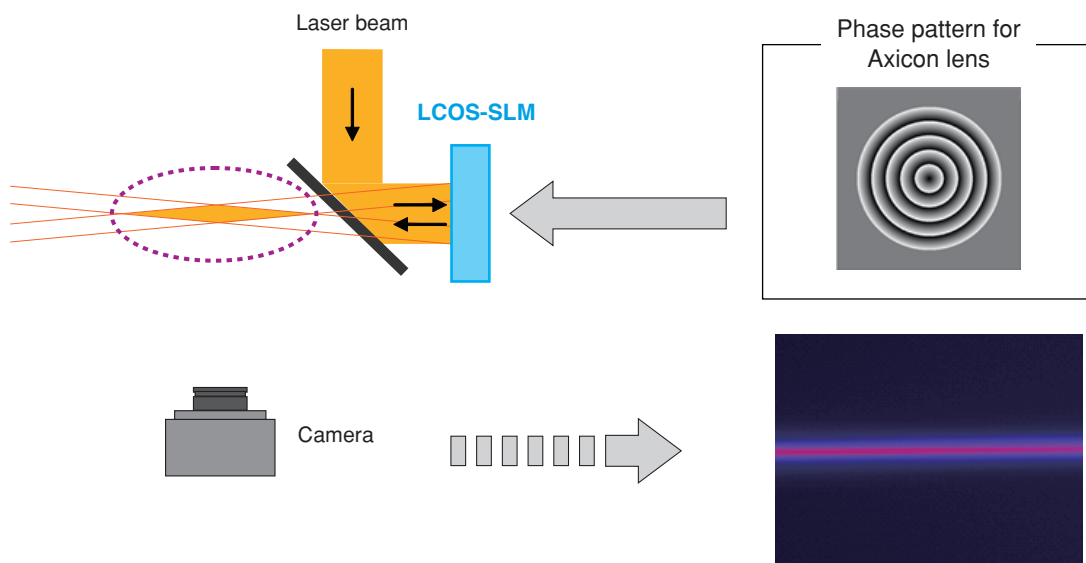

► Light sheet microscopy

Light sheet microscopy is one of fluorescent microscopic techniques used for bio-imaging, which can make dramatic reduction of photo toxicity and photo bleaching possible by illuminating a focal plane of a sample only. A lot of beams are being developed as illumination light sources, and a high sensitive camera is used for detection.

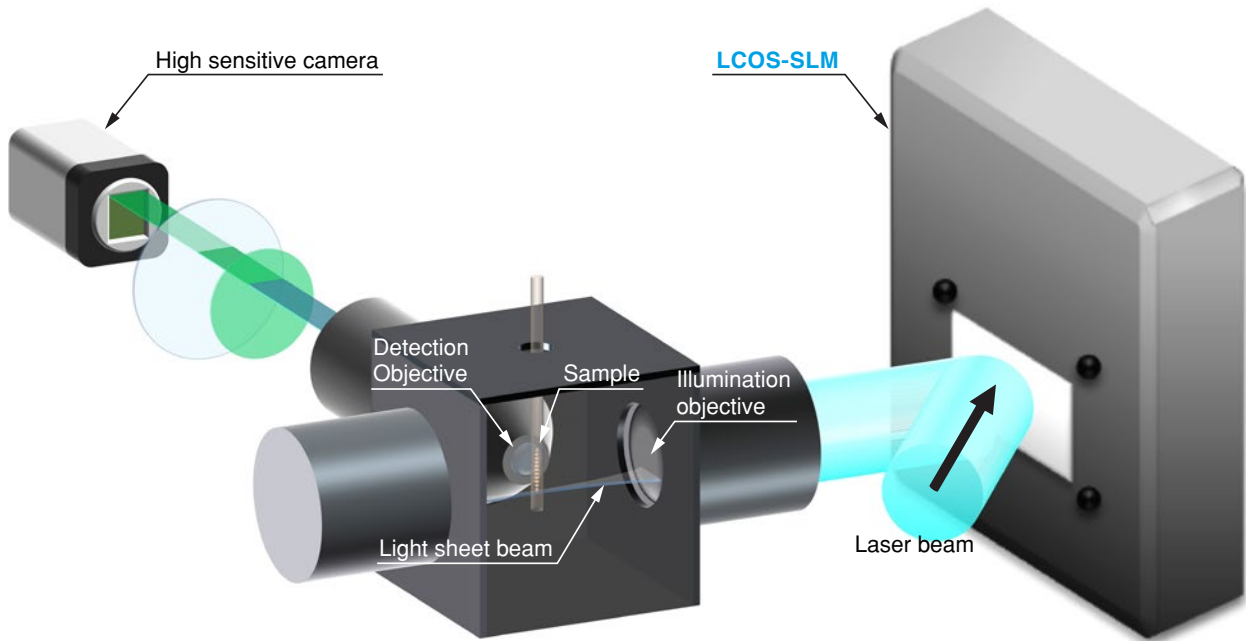

LCOS-SLM for material processing laser

An optimum LCOS-SLM corresponding to each laser for material processing is indicated in the table below.

Unprecedented laser processing can be realized by controlling 3D spaces including depth direction rather than just the processing points on a 2D plane.

Laser type	Wavelength (nm)	Optinum LCOS-SLM	Water-cooled type / Sapphire type
Yb:YAG, Yb:Fiber	515	X15213-16	X15213-16L/-16R
Nd:YAG	532	X15213-13 X15213-16	X15213-16L/-16R
Ti:S	800	X15213-02	X15213-02L/-02R
Nd:YAG	1064	X15213-03B	X15213-03BL/-03BR /-03CL/-03CR
Nd:YVO4	1064	X15213-03B	X15213-03BL/-03BR /-03CL/-03CR
Yb:YAG, Yb:Fiber	1030	X15213-03B	X15213-03BL/-03BR /-03CL/-03CR

Damage type

Damages to LCOS-SLM can be categorized into the 3 types below.

- Thermal damage to liquid crystal layer
- Erosive damage to dielectric mirror or aluminum mirror
- Optical damage to liquid crystal material

Thermal damage occurs from excessive input power, and the likely phenomena are described in order as below:

- ① Optical absorption at each constituent material of LCOS-SLM
- ② Temperature increase caused by absorption of light energy
- ③ Degradation of birefringence caused by temperature increase of liquid crystal
- ④ Disappearance of birefringence when liquid crystal temperature reaches phase transition temperature
- ⑤ Irreversible deterioration caused by liquid crystal boiling when temperature increase reaches the limit

The above mentioned thermal damages can be prevented by monitoring the characteristic of birefringence.

Erosive damage occurs from excessive peak input power that is beyond a threshold level, and the damage cannot be reversed.

Results of laser irradiation

LCOS-SLM might be damaged by high-power lasers even though it has high reliability in general. As an example, the table below shows laser irradiation results for some products.

► X15213-02

Light source				Beam size (mm) [at 1/e ²]	Irradiation time	Irradiation intensity		Peak power		Result	
Type	Wavelength (nm)	Pulse width	Repetition frequency (kHz)			Average output power (W)	Output power per area (W/cm ²)	Peak output power	Output power per area	Damage	Characteristic change
Ti:S laser (pulse)	800	50 fs	1	φ9	3 hours	2.7	4.3	108 GW	170 GW/cm ²	None	Seen
Ti:S laser (pulse)	800	50 fs	1	φ11	10 hours	2.7	2.9	108 GW	114 GW/cm ²	None	None
Ti:S laser (pulse)	800	30 fs	0.01	φ18	6 hours	0.05	0.02	333 GW	131 GW/cm ²	None	None

► X15213-03B

Light source				Beam size (mm) [at 1/e ²]	Irradiation time	Irradiation intensity		Peak power		Result	
Type	Wavelength (nm)	Pulse width	Repetition frequency (kHz)			Average output power (W)	Output power per area (W/cm ²)	Peak output power	Output power per area	Damage	Characteristic change
YAG laser (CW)	1064	-	-	φ2.5	1 hours	2.0	40.7	-	-	None	None
YAG laser (pulse)	1064	200 ns	80	φ2.5	1 hours	2.0	40.7	0.25 KW	5.1 KW/cm ²	None	None
Pulse laser	1030	670 fs	1	φ4.5	10 hours	0.6	3.8	1.8 GW	11.3 GW/cm ²	None	None
Pulse laser	1030	1.37 ps	30	φ8.11	8 hours	5.2	10.1	0.25 GW	0.49 GW/cm ²	None	None
Pulse laser	1030	11.4 ns	10	φ13	8 hours	17.4	13.1	0.31 MW	0.23 MW/cm ²	None	None

* The data was acquired by the experiment with previous model. Successor model, -03B series offers similar or better performance.

► X15213-03CL/-03CR

Light source				Beam size (mm) [at 1/e ²]	Irradiation time	Irradiation intensity		Peak power		Result	
Type	Wavelength (nm)	Pulse width	Repetition frequency (kHz)			Average output power (W)	Output power per area (W/cm ²)	Peak output power	Output power per area	Damage	Characteristic change
Pulse laser (CW)	1070	-	-	φ5.5	10 hours	743	3127	-	-	None	None ^{*1}

*1 The phase modulation characteristics depend on water cooling conditions. Please contact us for details.

► X15213-13

Light source				Beam size (mm) [at 1/e ²]	Irradiation time	Irradiation intensity		Peak power		Result	
Type	Wavelength (nm)	Pulse width	Repetition frequency (kHz)			Average output power (W)	Output power per area (W/cm ²)	Peak output power	Output power per area	Damage	Characteristic change
CW laser	532	-	-	φ8.45	8 hours	10	17.8	-	-	None	None

► X15213-16

Light source				Beam size (mm) [at 1/e ²]	Irradiation time	Irradiation intensity		Peak power		Result	
Type	Wavelength (nm)	Pulse width	Repetition frequency (kHz)			Average output power (W)	Output power per area (W/cm ²)	Peak output power	Output power per area	Damage	Characteristic change
Pulse laser	515	4 ps	25	φ3.7	27 hours	0.162	1.5	1.6 MW	30 MW/cm ²	None	None
					60 hours	0.36	3.3	3.6 MW	67 MW/cm ²	Seen	Seen

Image gallery

► Insite of glass is processed with CGH projection of fs laser

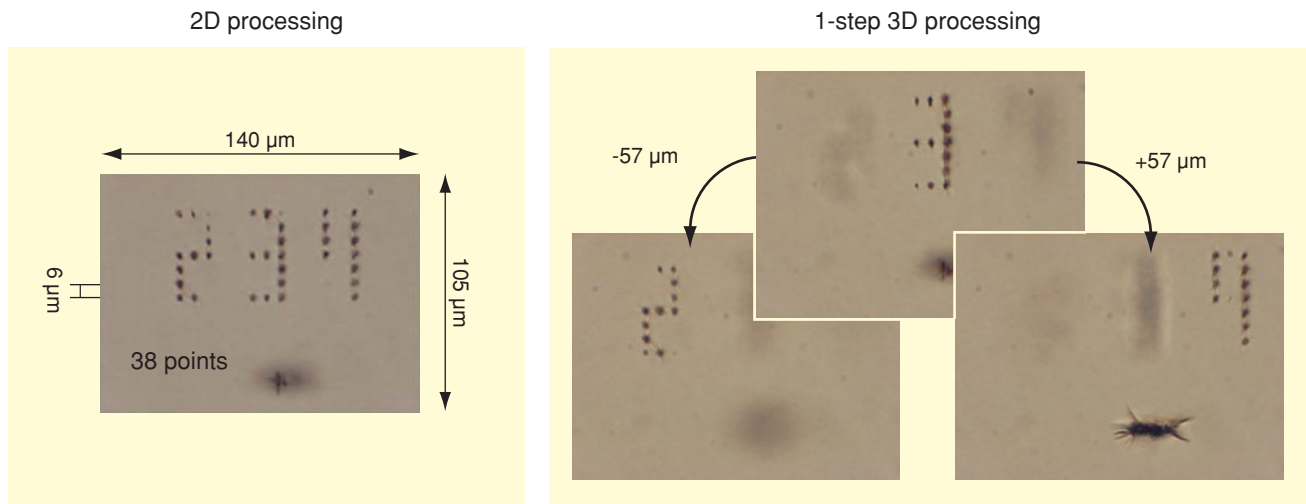

- Objective lens: NA=0.3 (Nikon)
- Irradiation intensity: 250 mW (ϕ 8 mm aperture)
- BK7

► Laser beam condensation inside transparent material

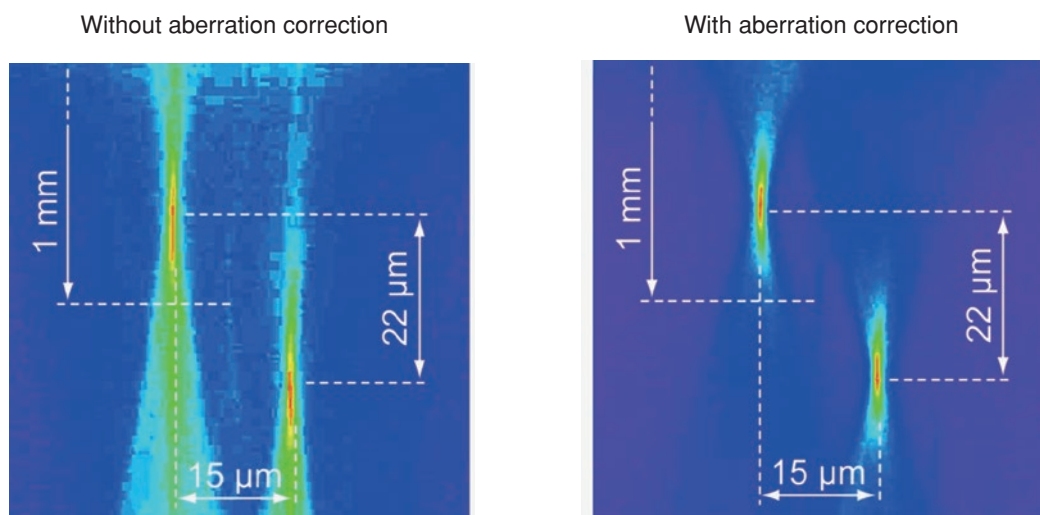

Features

Feature 1 High light utilization efficiency

The X15213 series have high light utilization efficiency, which is defined a ratio of the 0th order diffraction light level to the input light level. The high light utilization efficiency mainly depends on reflectivity, and the amount of diffraction loss caused by the pixel structure. We adopted advanced CMOS technology to make the diffraction loss smaller. As a result, the diffraction loss is less than 5%. The -02/-03B/-05/-13/-16/-19 types have a dielectric mirror which has high reflectivity. Therefore, these types have very high light utilization efficiency. The -01/-07/-08 types have relatively low light utilization efficiency compared to the ones with the dielectric mirror but have wide spectral response characteristics.

Feature 2 Pure, linear and precise phase control

The X15213 series can achieve phase modulation of more than 2π radians over the 400 to 2050 nm readout wavelength range. The X15213 series comes pre-calibrated from the factory for a specified wavelength range to have more than 2π radians of phase modulation and its linear characteristics. The figure below shows typical phase modulation characteristics. A phase shift of 2π radians or more and a linear phase response are achieved. The phase modulation curves for 95 % pixels lies within $\pm 2\sigma$.

Phase modulation (typical example)

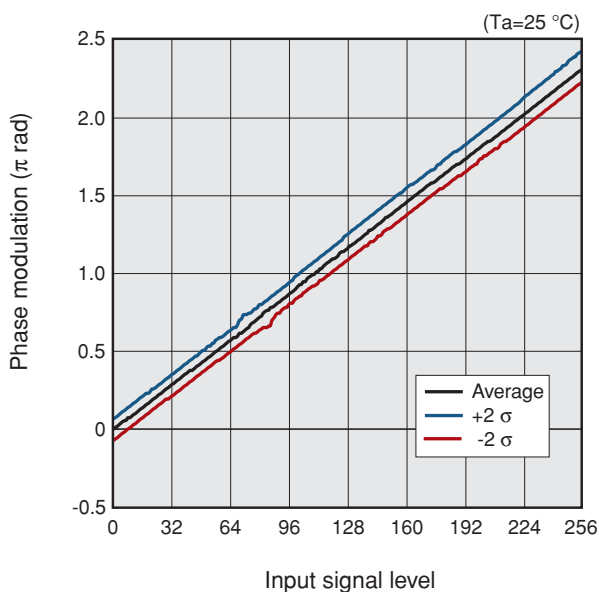

Feature 3 High diffraction efficiency

The X15213 series is a pure phase SLM with high precision phase control; therefore, it has high diffraction efficiency close to the theoretical values. The left figure shows images of diffracted spots, when a multi-level phase grating is formed in the X15213 series. The right figure shows typical diffraction efficiency characteristics. The diffraction efficiency here is the ratio of the 1st order diffraction intensity to the 0th order intensity of light without modulation (no pattern).

■ Diffracted spots images

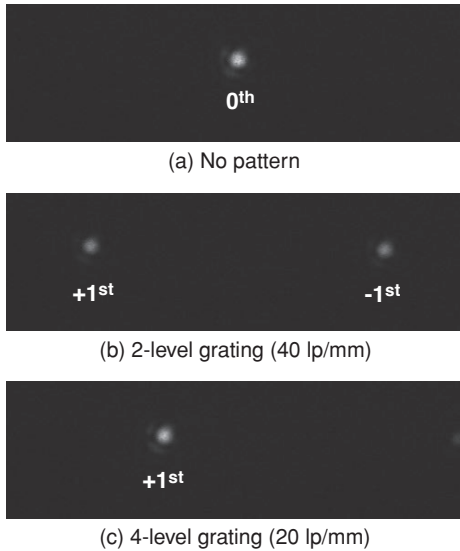

■ Diffraction efficiency (typical example)

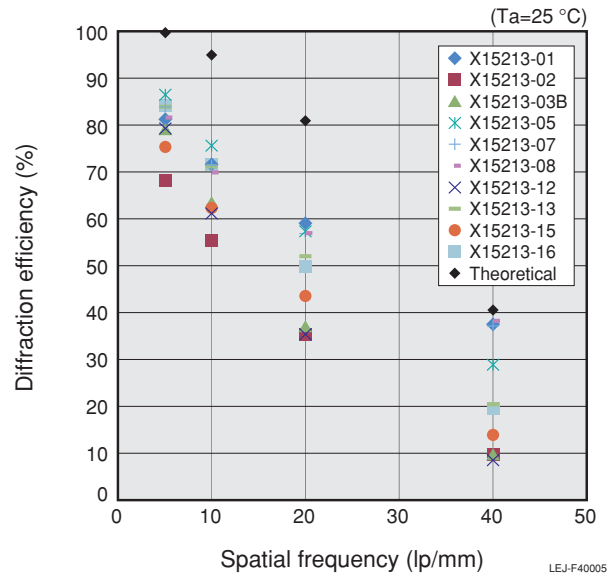

Feature 4 Excellent power handling capability

Although the X15213 series achieves versatility and high reliability, there is a concern that characteristics may change depending on the peak power and average power of the incident light when irradiated with high power laser light. When the peak power is high, 2 photon absorption occurs in the LC layer, which leads to characteristic changes and damage. When the average power is high, a characteristic change occurs due to heat generation. The water-cooled type and the sapphire type with improved heat dissipation efficiency are effective in suppressing this characteristic change caused by heat generation.

■ Phase modulation characteristics of sapphire type (typical example)

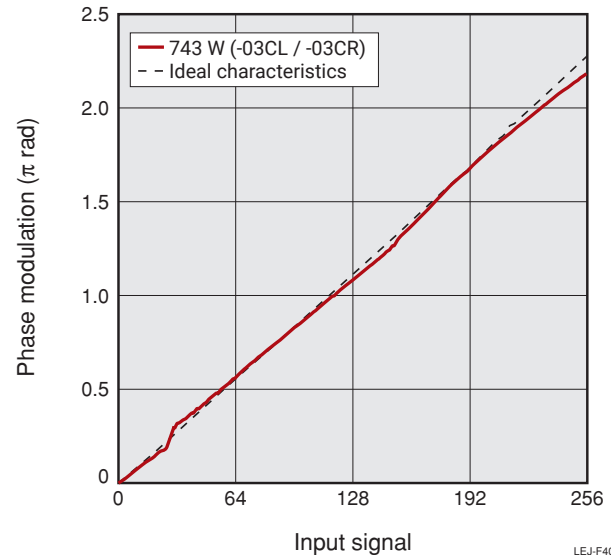

* The phase modulation characteristics depend on water cooling conditions. Please contact us for details.

Type	Type no.	Recommended average power
Aluminum mirror type	X15213-01/-07/-08	≤0.5 W *1
Dielectric mirror type	X15213-02/-03B/-05/-12/-13/-15/-16/-19	≤10 W
Water-cooled type	X15213-02L/-02R/-12L/-12R/ -15L/-15R/-16L/-16R/-19L/-19R	≤100 W
	X15213-03BL/-03BR	≤200 W *2
Sapphire type	X15213-03CL/-03CR	≥700 W *2

*1 500 mW/cm² or less per unit area is recommended.

*2 As it also depends on irradiation conditions please contact us for details.

Related product “LCOS-SLM embedded module X15223 series”

A compact and low cost driver circuit is connected to a compact head module with a flexible cable. A phase only spatial light modulator can be integrated easily for industrial applications.

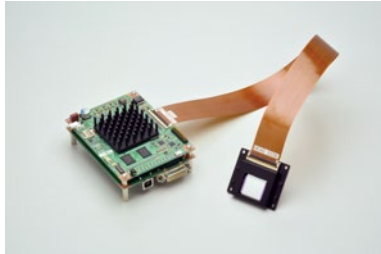

■ Block diagram

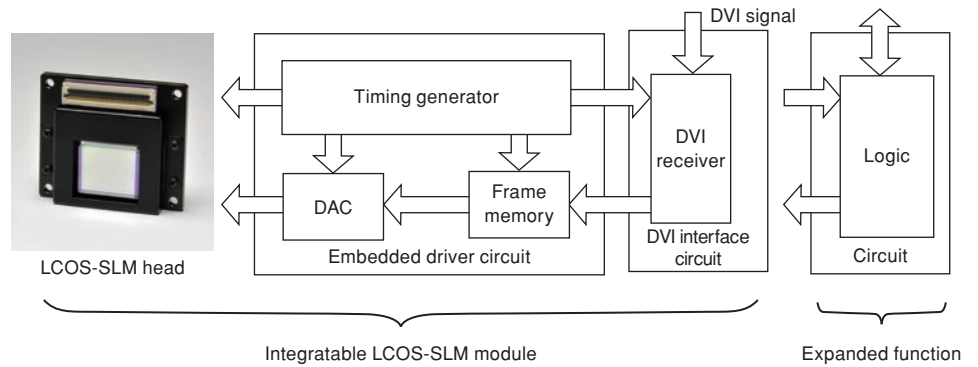

KACCC1005EA

FAQ

Q: Do you develop the LCOS-SLM system and the LCOS chip itself in-house?

A: Yes, the whole system including the CMOS backplane and optical thin film is designed and manufactured in-house by HAMAMATSU. This means that the LCOS-SLM is individually optimized to the readout laser and the specific application.

Q: Can you offer custom LCOS-SLM?

A: Yes, as mentioned above, all parts of the LCOS-SLM are designed in-house at the HAMAMATSU factory, meaning that there is a higher degree of flexibility with regard to providing customized LCOS-SLM. Please contact us with your exact requirements, and we'll see what we can do.

Q: Do we need to make baseline measurements for correcting the device characteristic and flatness?

A: No, all LCOS-SLMs are delivered with a linear phase characteristic data, and an individual flatness correction data is provided.

Q: Does your LCOS-SLM show phase fluctuations/flickering?

A: We use carefully designed control electronics to electrically drive the LCOS chip. Consequently, the phase fluctuations and flickering are negligible. For further information, please consult us and we can provide further details.

Q: What is the light utilization efficiency of the LCOS-SLM X15213 series?

A: The total light utilization efficiency is related to the reflectivity and the diffraction loss of the pixel structure. The reflectivity is determined by the "mirror" characteristics of either an aluminum mirror or the highly reflective dielectric mirror with up to 97 % reflectivity. Also the pixel fill factor is relevant to minimizing diffraction losses due to the pixel structure (the higher fill factor the better). The diffraction loss is dependent on several factors of the LCOS-SLM design like pixel size, fill factor and LC material.

Q: Is there a special interface needed to control the LCOS-SLM?

A: No, all you need is to use a standard graphics card with a DVI-D output, ideally a card with two DVI-D ports to connect to a monitor and to the LCOS-SLM.

Q: What is the laser damage threshold?

A: It depends if you use the -01/-07/-08 with an aluminum mirror or the -02/-03B/-05/-12/-13/-15/-16/-19 with the dielectric mirror. The latter can withstand much higher CW and pulsed laser powers. We tested several lasers, and you can find the results in the LCOS-SLM "Technical Information" (ask us for a copy). If your special laser parameters are not listed, please ask us and we are happy to help ensure you use the LCOS-SLM safely.

Q: What wavelengths does LCOS-SLM operate at?

A: We have a range of LCOS-SLM to cover wavelengths between 400 nm and 2050 nm.

Q: What kind of LCOS-SLM do you manufacture?

A: Our LCOS-SLM uses parallel-aligned, nematic liquid crystals and a CMOS backplane for the addressing. They are reflective devices.

Q: Do you offer demo loans?

A: Yes, we can provide you with a demo system. You can then use the LCOS-SLM in your lab and test its performance directly within your setup. Please contact us to discuss your experiment and arrange the schedule. This demo loan is free of charge for you. We kindly ask you to send it back to our office and summarize your findings on completion of the loan.

Q: Do you got a price list for the SLM?

A: The LCOS-SLM is individually optimized for the user's application and readout laser, so please call or e-mail us to determine which LCOS-SLM will be optimal for your application and we'll provide quotations right away.

Q: What is the delivery time of the LCOS-SLM?

A: The standard delivery time will depend on the manufacturing cycle. The typical lead time is 6 to 8 weeks from receipt of order though sometimes deliveries can be shorter than this, and we do hold some LCOS-SLM in loan stock should something be urgently required.

Q: What is your standard warranty?

A: The standard warranty is 12 months from receipt of product.

Related thesis / Technical materials

► Laser processing

- Modified Alvarez lens for high-speed focusing.
Optics Express 25 (24): 29847-29855 (2017)
- Massively parallel femtosecond laser processing
Optics Express 24 (16): 18513-18524 (2016)
- Three-dimensional vector recording in polarization sensitive liquid crystal composites by using axisymmetrically polarized beam.
Optics Letters 41 (3): 642-645 (2016)
- Abruptly autofocusing beams enable advanced multiscale photo-polymerization.
Optica 3 (5): 525-530 (2016)
- Laser material processing with tightly focused cylindrical vector beams.
Applied Physics Letters 108 (22): 221107 (2016)

► Adaptive optics

- Adaptive optics scanning laser ophthalmoscope using liquid crystal on silicon spatial light modulator : performance study with involuntary eye movement
Jpn. J. Appl. Phys. 56, 09NB02 (2017).

► Beam shaping/Pulse shaping

- 9-kW peak power and 150-fs duration blue-violet optical pulses generated by GaInN master oscillator power amplifier.
Optics Express 25 (13): 14926-14934 (2017)
- Sub-diffraction-limited fluorescent patterns by tightly focusing polarized femtosecond vortex beams in silver-containing glass.
Optics Express 25 (9): 10565-10573 (2017)
- Creating a nondiffracting beam with sub-diffraction size by a phase spatial light modulator.
Optics Express 25 (6): 6274-6282 (2017)
- Vortex-free phase profiles for uniform patterning with computer-generated holography.
Optics Express 25 (11): 12640-12652, 2017
- Realization of multiform time derivatives of pulses using a Fourier pulse shaping system.
Optics Express 25 (4): 4038-4045 (2017)
- Diffractive fan-out elements for wavelength-multiplexing subdiffraction-limit spot generation in three dimensions
Applied Optics 55 (23): 6371-6380 (2016)
- Fluid flow vorticity measurement using laser beams with orbital angular momentum.
Optics Express 24 (11): 11762-11767 (2016)
- Comparison of beam generation techniques using a phase only spatial light modulator.
Optics Express 24 (6): 6249-6264 (2016)
- Mode crosstalk matrix measurement of a 1 km elliptical core few-mode optical fiber.
Optics Letters 41 (12): 2755-2758 (2016)
- Arbitrary shaping of on-axis amplitude of femtosecond Bessel beams with a single phase-only spatial light modulator.
Optics Express 24 (11): 11495-11504 (2016)

- Mitigating self-action processes with chirp or binary phase shaping.
Optics Letters 41 (1): 131-134 (2016)
- High-quality generation of a multispot pattern using a spatial light modulator with adaptive
Optics Letters 37, 3135 (2012)

► Microscopy applications

- Raman imaging through a single multimode fiber.
Optics Express 25 (12): 13782-13798 (2017)
- Transmission-matrix-based point-spread-function engineering through a complex medium
Optica 4 (1): 54-59 (2017)
- Three-dimensional spatiotemporal focusing of holographic patterns.
Nature Communications 7: 11928 (2016)
- Colored point spread function engineering for parallel confocal microscopy.
Optics Express 24 (24): 27395-27402 (2016)
- Three-dimensional STED microscopy of aberrating tissue using dual adaptive optics.
Optics Express 24 (8): 8862-8876 (2016)
- A V0 core neuronal circuit for inspiration.
Nature Communications 8 (1): 544 (2017)
- An adaptive approach for uniform scanning in multifocal multiphoton microscopy with a spatial light modulator
Optics Express 22 (1), 633-645 (2014).

► Optical manipulation/others

- Using back focal plane interferometry to probe the influence of Zernike aberrations in optical tweezers.
Optics Letters 42 (15): 2968-2971 (2017)
- Vector assembly of colloids on monolayer substrates.
Nature Communications 8: 15778 (2017)
- Cooperative Micromanipulation Using the Independent Actuation of Fifty Microrobots in Parallel.
Scientific Reports 7 (1): 3278 (2017)
- Single-pixel digital holography with phase-encoded illumination.
Optics Express 25 (5) 4975-4984 (2017)
- Single-shot incoherent digital holography using a dual-focusing lens with diffraction gratings.
Optics Letters 42 (3): 383-386 (2017)
- Shaping of cylindrical and 3D ellipsoidal beams for electron photoinjector laser drivers.
Applied Optics 55 (7): 1630-1635 (2016)
- Enhanced terahertz wave emission from air-plasma tailored by abruptly autofocusing laser beams.
Optica 3 (6): 605-608 (2016)

A list of other related thesis is on the following website.

<http://www.hamamatsu.com/jp/en/community/lcos/publications/index.html>

Product specifications are subject to change without prior notice due to improvements or other reasons. This document has been carefully prepared and the information contained is believed to be accurate. In rare cases, however, there may be inaccuracies such as text errors. Before using these products, always contact us for the delivery specification sheet to check the latest specifications.

The product warranty is valid for one year after delivery and is limited to product repair or replacement for defects discovered and reported to us within that one year period. However, even if within the warranty period we accept absolutely no liability for any loss caused by natural disasters or improper product use. Copying or reprinting the contents described in this material in whole or in part is prohibited without our prior permission.

HAMAMATSU

www.hamamatsu.com

HAMAMATSU PHOTONICS K.K., Laser Promotion Division, Business Promotion G.

314-5, Shimokanzo, Iwata City, Shizuoka Pref., 438-0193, Japan, Telephone: (81)539/63-0230, Fax: (81)539/62-2205, E-mail: sales-laser@lpd.hpk.co.jp

U.S.A.: HAMAMATSU CORPORATION: 360 Foothill Road, Bridgewater, NJ 08807, U.S.A., Telephone: (1)908-231-0960, Fax: (1)908-231-1218 E-mail: usa@hamamatsu.com

Germany: HAMAMATSU PHOTONICS DEUTSCHLAND GMBH.: Arzbergerstr. 10, 82211 Herrsching am Ammersee, Germany, Telephone: (49)8152-375-0, Fax: (49)8152-265-8 E-mail: info@hamamatsu.de

France: HAMAMATSU PHOTONICS FRANCE S.A.R.L.: 19 Rue du Saule Trapu, Parc du Moulin de Massy, 91882 Massy Cedex, France, Telephone: (33)1 69 53 71 00, Fax: (33)1 69 53 71 10 E-mail: infos@hamamatsu.fr

United Kingdom: HAMAMATSU PHOTONICS UK LIMITED: 2 Howard Court, 10 Tewin Road, Welwyn Garden City, Hertfordshire, AL7 1BW, UK, Telephone: (44)1707-294888, Fax: (44)1707-325777 E-mail: info@hamamatsu.co.uk

North Europe: HAMAMATSU PHOTONICS NORDEN AB: Torshamnsgatan 35, 16440 Kista, Sweden, Telephone: (46)8-509-031-00, Fax: (46)8-509-031-01 E-mail: info@hamamatsu.se

Italy: HAMAMATSU PHOTONICS ITALIA S.R.L.: Strada della Moia, 1 int. 6 20044 Arese (Milano), Italy, Telephone: (39)02-93 58 17 33, Fax: (39)02-93 58 17 41 E-mail: info@hamamatsu.it

China: HAMAMATSU PHOTONICS (CHINA) CO., LTD.: 1201, Tower B, Jiaming Center, 27 Dongsanhuan Beilu, Chaoyang District, 100020 Beijing, P.R. China, Telephone: (86)10-6586-6006, Fax: (86)10-6586-2866 E-mail: hpc@hamamatsu.com.cn

Taiwan: HAMAMATSU PHOTONICS TAIWAN CO., LTD.: 13F-1, No.101, Section 2, Gongdao 5th Road, East Dist., Hsinchu City, 300046, Taiwan(R.O.C) Telephone: (886)3-659-0080, Fax: (886)3-659-0081 E-mail: info@hamamatsu.com.tw

Cat. No. LLAP3012E03
May 2024