

代码	类型	材质	轴承	预期寿命
YEDZH07	轴流风扇	AC型	PBT 双滚珠	50000H(25°C)

CE

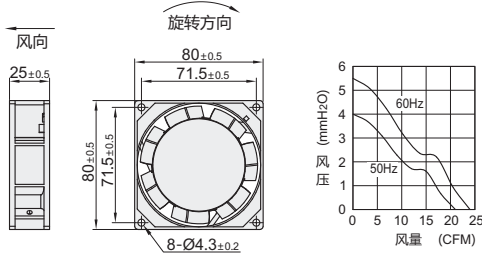

外形尺寸: 80



外形尺寸: 92

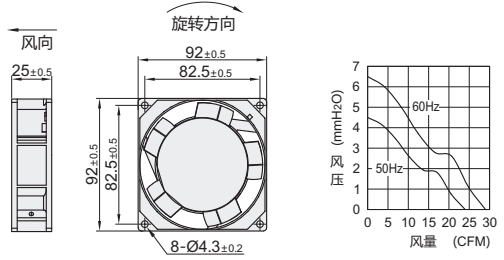

外形尺寸: 120B

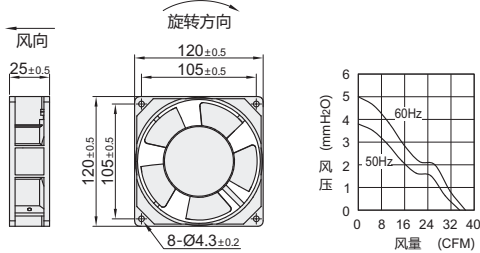

外形尺寸: 120

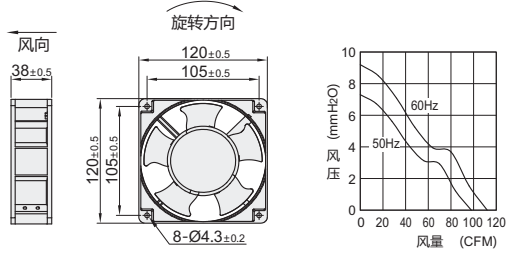

外形尺寸: 150

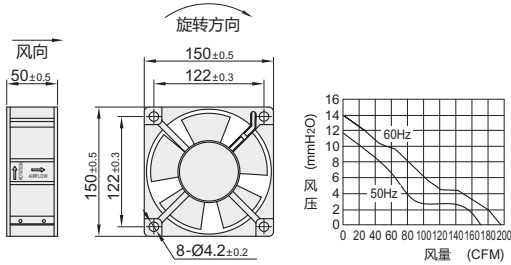

外形尺寸: 172

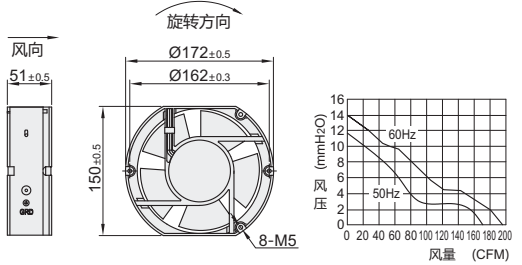

外形尺寸: 200

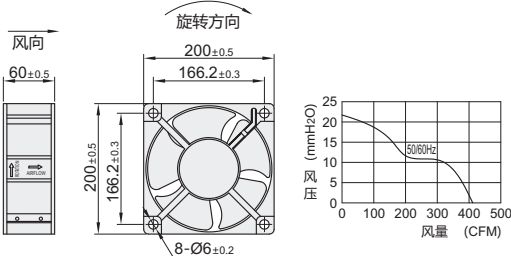

外形尺寸: 220

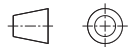
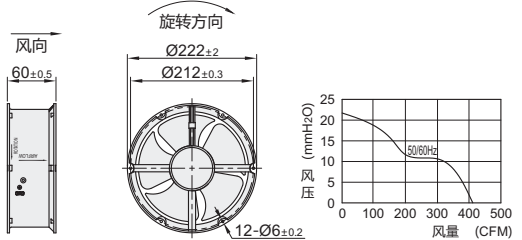

视角标准: 第一视角

外形尺寸: 225

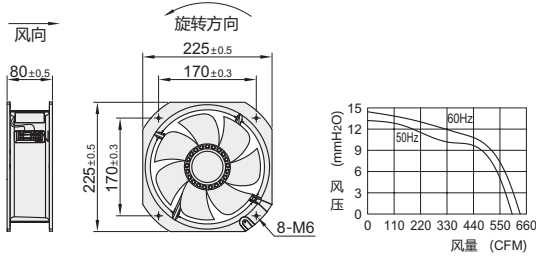

外形尺寸: 254

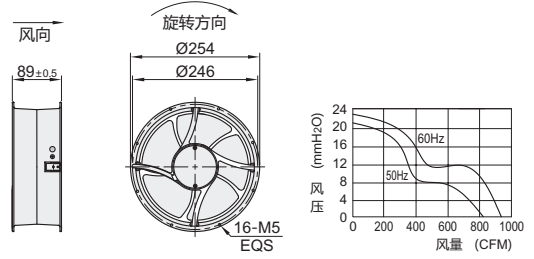

外形尺寸: 280

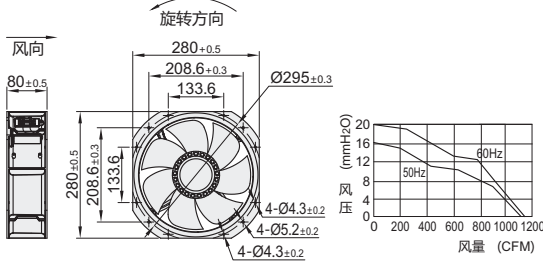

外形尺寸: 340

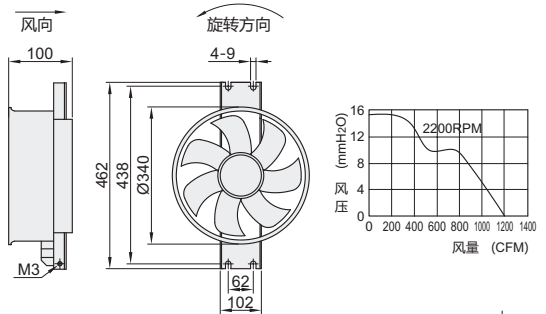

视角标准: 第一视角

型号		适配附件	长×宽×高 (mm)	输入电压	频率 (Hz)	功率 (W)	电流 (A)	转速 (RPM)	风量 (CFM)	风压 (mm-H ₂ O)	噪音 (Db[A])	重量 (g)
代码	外形尺寸											
YEDZHJ07	80	铁网 YEDZHJ42 过滤网 YEDZHJ41 或 百叶窗 YEDZHJ43	80×80×25	AC220/240V	50/60	16/12	0.08/0.07	2550/2900	25/29	3.31/4.44	34/37.2	210
	92		92×92×25			2450/2800	25/28.57	3.5/4.57	36/38.9	236		
	120B		120×120×25			18/16	0.11/0.1	2100/2200	36/37.71	2.2/2.41	35/36	275
	120		120×120×38			0.13/0.11	2650/2950	85/98	6.4/7	45/48	432	
	150		150×150×50			38/36	0.25/0.23	2600/2300	168/149	10.5/9.2	48/45	830
	172		172×150×51			45/48	0.32/0.35	2600/3000	400/470	13.0/15.2	61/65	1500
	200		200×200×60			75/85	0.32/0.4	2600/2800	560/680	16.5/20.0	60/64	2100
	220		Ø222×60			50/65	0.22/0.28	2750/3000	750/920	17.2/19.5	58/62	2000
	225		225×225×80			100/120	0.45/0.5	2600/2800	1059/1130	16.5/20.0	68/70	2800
	280		280×280×80			50	150	0.5	2200	1240	11.5	73
340	462×102×100											



请按图示订货

型号	
代码	外形尺寸
YEDZHJ07	80
	92

YEDZHJ07-80