

YIEDEA TECHNOLOGY

Push button & Indicator

▶▶ **A16 Series**

■ 按钮开关系列 及指示灯



特性 /Features

- ◆ 安装直径 /Installation diameter: 16mm
- ◆ 防护等级 /Degree of Protection: IP65
- ◆ 触点银镀金 /Silver Plated contact: 3μ
- ◆ 紧凑型设计 /Compact design saves space
- ◆ 灯罩防紫外线 /UV Protective lamp shade
- ◆ LED 超高亮冷光源 灯显示
Super bright LED cold light source lamp display

技术参数 Technical parameters

额定绝缘电压 Rated insulation voltage	250VAC/DC	
环境温度(不结露或结冰)Ambient temperature(no condensation or Ice)	-25℃~+55℃	
湿度(不结露或结冰)Humidity(no condensation or Ice)	45 至 85%RH(-5 至 +40℃) 45~85%RH(-5~+40℃)	
介电强度 Dielectric strength	2500VAC/1 分钟 2500VAC/1min	
动作频率 Operating frequency	1200 次操作 /小时(通电率:40%) 1200 time/hour(power-on ratio:40%)	
接触电阻 Contact resistance	30mΩ 或以下 30mΩ or below	
绝缘电阻 Insulation resistance	30mΩ 或以上(500VDC 高阻表) 30mΩ or above(500VDC megameter)	
防护等级 Protection grade	IP40 IP65	
寿命(动作) Performance life	机械 Mechanical	按钮开关 Push-button switch 瞬动型:1 百万次 Momentary type:1million times 交替型:250000 次 On off type:250000 times 推入锁定, 转动复位:100000 次 Push and lock, turn to reset:100000 times 钥匙开关和选择开关:250000 次 Key switch and selector switch:250000 times
	电气 Electric	100000 次(220V AC 0.7A)

触点额定值 Contact rated value

额定热电流 Rated hot current	5A		
额定工作电压 Rated working voltage	24V	110V	220V
最大电流 Max current	AC(阻性负载) AC(resistance load)	1.0A	0.5A
	DC(阻性负载) DC(resistance load)	1.0A	0.2A
LED 额定值 LED Ratings	额定工作电压 Rated working voltage	6VDC 12VDC 24VDC	
	额定工作电流 Rated working current	10mA	

LED 灯珠参数 LED Ratings

额定电压 Rated Voltage	电流 Current
5V DC ± 5%	8mA
	AC:A,R,W,Y:8mA
	G,S:7mA
6V AC/DC(± 10%)	DC:A,R,W,Y:6mA
	G,S:5mA
	AC:9mA DC:8mA
12V AC/DC(± 10%)	AC:9mA DC:8mA
24V AC/DC(± 10%)	AC:9mA DC:8mA

端子排列图/ Terminal style

右侧产品的底座看成正面时，端子排列顺序及内部电路图。
As shown at right, the base of product to be seen as front side, which show terminal disposition and inside coil drawing.

产品出产时基本安装触点座 1C(1a+1b)，在需要时请指定增加最多 3C(1a+1b)。
Product assemble contact 1C(1a+1b), If needed, Please appoint to add at least 3c(1a+1b).

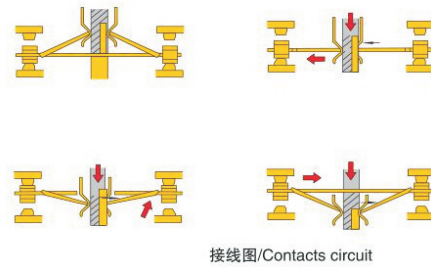
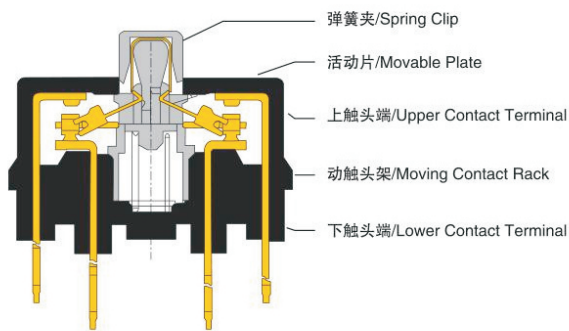
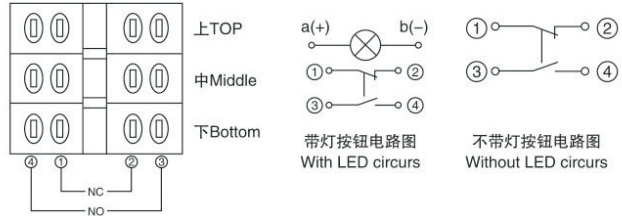

安装尺寸及接线图 / Installation size & Contacts circuit

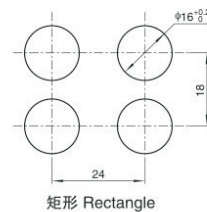
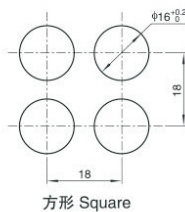
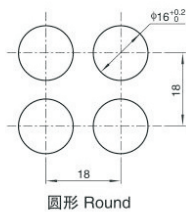

使用注意事项 / Important Information

- 在锁定状态下请勿拆卸交替型按钮，否则会导致内部结构损坏。
- 轻松旋转选择开关和钥匙开关就可，操作请勿用力过度(1N.m 以上)
- 安装 A16 的时候，请注意安装板下不能超过防护罩最大 2.6mm，防水罩最大 2.0mm，护环最大 1mm
- 安装时请使用专用扳手，合适的禁锢扭矩 0.6-1N.m
- 焊接作业时候注意以下几点:
 - 1) 烙铁的功率为 30W 以下。
 - 2) 焊锡必须带松脂焊锡丝。
 - 3) 焊接持续时间 30W 时 5 秒，20W 时 10 秒以内。
- 请在规定的工作环境温度和湿度范围内使用，封闭型的请不要在受油，水浸入及积尘的场所使用，此场所使用防水开关，或使用专门的防护罩。
 1. In the lock state do not open the alternate type button, it could lead to internal structure damage.
 2. Easily rotate choose Switch and Key Switch can, operation do not excessive force (1N.m above)
 3. Installation of us A16, please pay attention to install board can't more than cover the biggest 2.6mm, waterproof cover the biggest 2.0mm, the largest ring 1mm.
 4. When installation, please use the special spanner, appropriate imprison torque to 0.6-1N.m
 5. Welding operations, pay attention to the following:
 - 1) Soldering pen for 30W power below.
 - 2) Solder must bring gum rosin solder wire.
 - 3) Welding duration when 30W 5 seconds, when 20W within 10 seconds.

按钮开关系列及指示灯



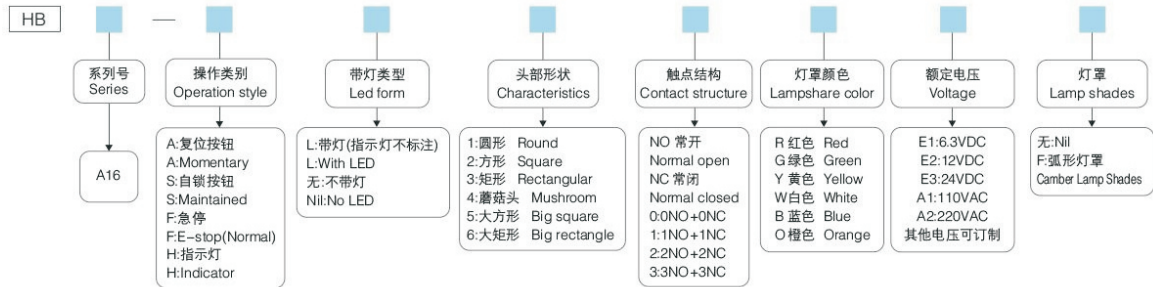



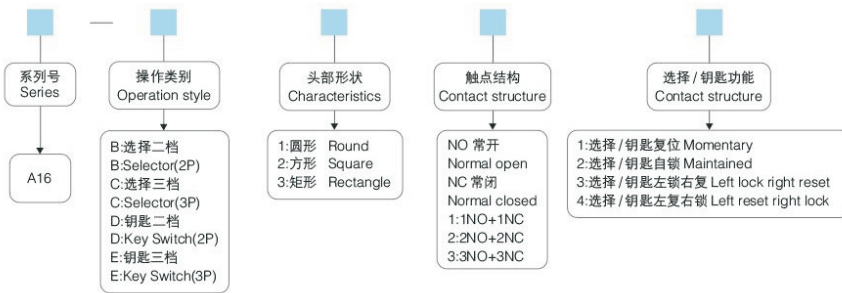





型号命名 / Select code



选择和钥匙开关命名方式 Selector and Key Switch Select Code



选择钮, 钥匙钮手柄位置 Selector and Key Switch Handle Positon

操作位规格 Operation		触点 Contact	
90° 2位 2 Positon	 自锁 Maintained	 自复 Momentary	单刀 SPDT 
	 自锁 Maintained	 左锁右复 Left lock Right reset	 自复 Left reset Right lock
90° 3位 3 Positon	 自锁 Maintained	 左锁右复 Left lock Right reset	三刀 DPDT 
	 自复 Momentary	 自复 Momentary	









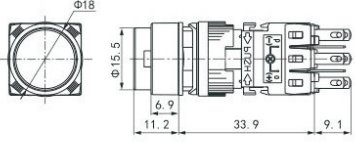

选择 / 钥匙旋转角度 90° 是基本 Selector/Key basic rotation angle 90°

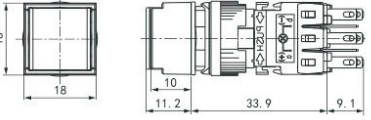

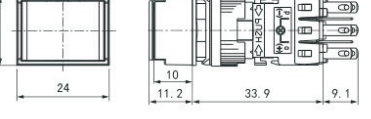

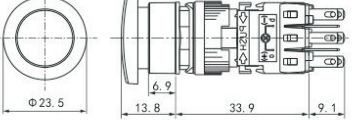

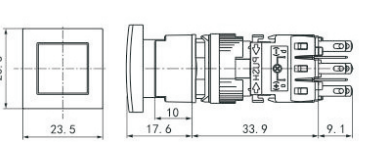

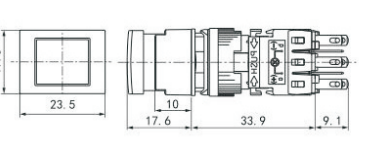

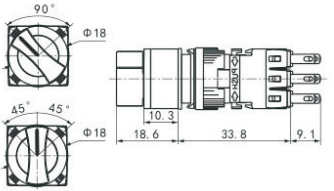
区分/Sort	复位方式/Reset Style				钥匙拔出位置/KEY Out Positon					
	自锁 Maintained	自复/Momentary								
3段/3 Positon	⊗	⊙			⊗	⊗	⊗			
代号/Code	2	0			A	B	D			
3段/3 Positon	⊕	⊙	⊙	⊙	⊗	⊗	⊗	⊗	⊙	⊗
代号/Code	3	7	6	1	A	B	C	D	E	F

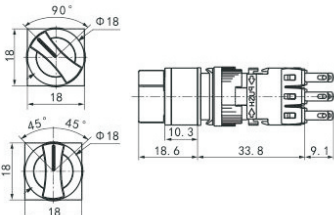
YIEDEA TECHNOLOGY

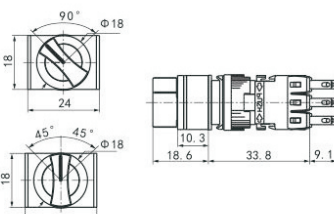
➤ A16 Series

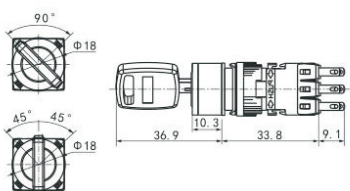
Push button & Indicator

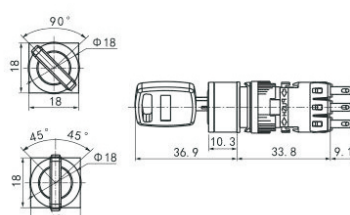

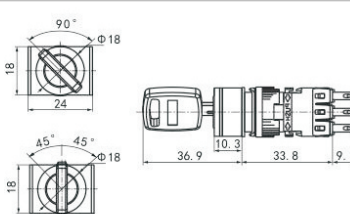
名称 / 外观 Product appearance	操作类别 Operation	带灯形式 Led form	触点 Contact	产品型号 Model	灯罩颜色 Top Color	外形尺寸 Overall dimension
圆形 Circular 	复位 Momentary	不带灯 Without LED	1NO+1NC	A16-A11 ●	●: 灯罩颜色 Lampshade color R 红色 Red G 绿色 Green Y 黄色 Yellow W 白色 White B 蓝色 Blue O 橙色 Orange	
			2NO+2NC	A16-A12 ●		
			3NO+3NC	A16-A13 ●		
		带灯 With LED	1NO+1NC	A16-AL11 ●		
			2NO+2NC	A16-AL12 ●		
			3NO+3NC	A16-AL13 ●		
	自锁 Maintained	不带灯 Without LED	1NO+1NC	A16-S11 ●		
			2NO+2NC	A16-S12 ●		
		带灯 With LED	1NO+1NC	A16-SL11 ●		
			2NO+2NC	A16-SL12 ●		
方形 Square 	复位 Momentary	不带灯 Without LED	1NO+1NC	A16-A21 ●		
			2NO+2NC	A16-A22 ●		
			3NO+3NC	A16-A23 ●		
		带灯 With LED	1NO+1NC	A16-AL21 ●		
			2NO+2NC	A16-AL22 ●		
			3NO+3NC	A16-AL23 ●		
	自锁 Maintained	不带灯 Without LED	1NO+1NC	A16-S21 ●		
			2NO+2NC	A16-S22 ●		
		带灯 With LED	1NO+1NC	A16-SL21 ●		
			2NO+2NC	A16-SL22 ●		
矩形 Rectangular 	复位 Momentary	不带灯 Without LED	1NO+1NC	A16-A31 ●		
			2NO+2NC	A16-A32 ●		
			3NO+3NC	A16-A33 ●		
		带灯 With LED	1NO+1NC	A16-AL31 ●		
			2NO+2NC	A16-AL32 ●		
			3NO+3NC	A16-AL33 ●		
	自锁 Maintained	不带灯 Without LED	1NO+1NC	A16-S31 ●		
			2NO+2NC	A16-S32 ●		
		带灯 With LED	1NO+1NC	A16-SL31 ●		
			2NO+2NC	A16-SL32 ●		
蘑菇头 Mushroom 	复位 Momentary	不带灯 Without LED	1NO+1NC	A16-A41 ●		
			2NO+2NC	A16-A42 ●		
			3NO+3NC	A16-A43 ●		
		带灯 With LED	1NO+1NC	A16-AL41 ●		
			2NO+2NC	A16-AL42 ●		
			3NO+3NC	A16-AL43 ●		
	自锁 Maintained	不带灯 Without LED	1NO+1NC	A16-S41 ●		
			2NO+2NC	A16-S42 ●		
		带灯 With LED	1NO+1NC	A16-SL41 ●		
			2NO+2NC	A16-SL42 ●		
大方形 Large Square 	复位 Momentary	不带灯 Without LED	1NO+1NC	A16-A51 ●		
			2NO+2NC	A16-A52 ●		
			3NO+3NC	A16-A53 ●		
		带灯 With LED	1NO+1NC	A16-AL51 ●		
			2NO+2NC	A16-AL52 ●		
			3NO+3NC	A16-AL53 ●		
	自锁 Maintained	不带灯 Without LED	1NO+1NC	A16-S51 ●		
			2NO+2NC	A16-S52 ●		
		带灯 With LED	1NO+1NC	A16-SL51 ●		
			2NO+2NC	A16-SL52 ●		
大矩形 Large Rectangular 	复位 Momentary	不带灯 Without LED	1NO+1NC	A16-A61 ●		
			2NO+2NC	A16-A62 ●		
			3NO+3NC	A16-A63 ●		
		带灯 With LED	1NO+1NC	A16-AL61 ●		
			2NO+2NC	A16-AL62 ●		
			3NO+3NC	A16-AL63 ●		
	自锁 Maintained	不带灯 Without LED	1NO+1NC	A16-S61 ●		
			2NO+2NC	A16-S62 ●		
		带灯 With LED	1NO+1NC	A16-SL61 ●		
			2NO+2NC	A16-SL62 ●		



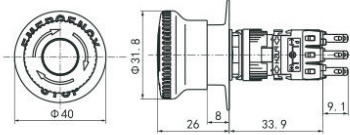

名称 / 外观 Product appearance	操作类别 Operation	操作规格 Operation specification	触点 Contact	产品型号 Model	灯罩颜色 Top Color	外形尺寸 Overall dimension
圆形 Circular 	复位 Momentary	选择二档 Selector(2P)	1NO+1NC 2NO+2NC 3NO+3NC	A16-B111 A16-B121 A16-B131		
		选择三档 Selector(3P)	1NO+1NC 2NO+2NC 3NO+3NC	A16-C111 A16-C121 A16-C131		
		选择二档 Selector(2P)	1NO+1NC 2NO+2NC 3NO+3NC	A16-B112 A16-B122 A16-B132		
	自锁 Maintained	选择二档 Selector(2P)	1NO+1NC 2NO+2NC 3NO+3NC	A16-C112 A16-C122 A16-C132		
		选择三档 Selector(3P)	1NO+1NC 2NO+2NC 3NO+3NC	A16-B211 A16-B221 A16-B231		
		选择二档 Selector(2P)	1NO+1NC 2NO+2NC 3NO+3NC	A16-C211 A16-C221 A16-C231		
方形 Square 	复位 Momentary	选择二档 Selector(2P)	1NO+1NC 2NO+2NC 3NO+3NC	A16-B211 A16-B221 A16-B231		
		选择三档 Selector(3P)	1NO+1NC 2NO+2NC 3NO+3NC	A16-C211 A16-C221 A16-C231		
		选择二档 Selector(2P)	1NO+1NC 2NO+2NC 3NO+3NC	A16-B212 A16-B222 A16-B232		
	自锁 Maintained	选择二档 Selector(2P)	1NO+1NC 2NO+2NC 3NO+3NC	A16-C212 A16-C222 A16-C232		
		选择三档 Selector(3P)	1NO+1NC 2NO+2NC 3NO+3NC	A16-B311 A16-B321 A16-B331		
		选择二档 Selector(2P)	1NO+1NC 2NO+2NC 3NO+3NC	A16-C311 A16-C321 A16-C331		
矩形 Rectangular 	复位 Momentary	选择二档 Selector(2P)	1NO+1NC 2NO+2NC 3NO+3NC	A16-B311 A16-B321 A16-B331		
		选择三档 Selector(3P)	1NO+1NC 2NO+2NC 3NO+3NC	A16-C311 A16-C321 A16-C331		
		选择二档 Selector(2P)	1NO+1NC 2NO+2NC 3NO+3NC	A16-B312 A16-B322 A16-B332		
	自锁 Maintained	选择二档 Selector(2P)	1NO+1NC 2NO+2NC 3NO+3NC	A16-C312 A16-C322 A16-C332		
		选择三档 Selector(3P)	1NO+1NC 2NO+2NC 3NO+3NC	A16-D111 A16-D121 A16-D131		
		选择二档 Selector(2P)	1NO+1NC 2NO+2NC 3NO+3NC	A16-E111 A16-E121 A16-E131		
圆形 Circular 	复位 Momentary	钥匙二档 Key switch(2P)	1NO+1NC 2NO+2NC 3NO+3NC	A16-D111 A16-D121 A16-D131		
		钥匙三档 Key switch(3P)	1NO+1NC 2NO+2NC 3NO+3NC	A16-E111 A16-E121 A16-E131		
		钥匙二档 Key switch(2P)	1NO+1NC 2NO+2NC 3NO+3NC	A16-D112 A16-D122 A16-D132		
	自锁 Maintained	钥匙二档 Key switch(2P)	1NO+1NC 2NO+2NC 3NO+3NC	A16-E112 A16-E122 A16-E132		
		钥匙三档 Key switch(3P)	1NO+1NC 2NO+2NC 3NO+3NC	A16-D211 A16-D221 A16-D231		
		钥匙二档 Key switch(2P)	1NO+1NC 2NO+2NC 3NO+3NC	A16-E211 A16-E221 A16-E231		
方形 Square 	复位 Momentary	钥匙二档 Key switch(2P)	1NO+1NC 2NO+2NC 3NO+3NC	A16-D211 A16-D221 A16-D231		
		钥匙三档 Key switch(3P)	1NO+1NC 2NO+2NC 3NO+3NC	A16-E211 A16-E221 A16-E231		
		钥匙二档 Key switch(2P)	1NO+1NC 2NO+2NC 3NO+3NC	A16-D212 A16-D222 A16-D232		
	自锁 Maintained	钥匙二档 Key switch(2P)	1NO+1NC 2NO+2NC 3NO+3NC	A16-E212 A16-E222 A16-E232		
		钥匙三档 Key switch(3P)	1NO+1NC 2NO+2NC 3NO+3NC	A16-D311 A16-D321 A16-D331		
		钥匙二档 Key switch(2P)	1NO+1NC 2NO+2NC 3NO+3NC	A16-E311 A16-E321 A16-E331		
矩形 Rectangular 	复位 Momentary	钥匙二档 Key switch(2P)	1NO+1NC 2NO+2NC 3NO+3NC	A16-D311 A16-D321 A16-D331		
		钥匙三档 Key switch(3P)	1NO+1NC 2NO+2NC 3NO+3NC	A16-E311 A16-E321 A16-E331		
		钥匙二档 Key switch(2P)	1NO+1NC 2NO+2NC 3NO+3NC	A16-D312 A16-D322 A16-D332		
	自锁 Maintained	钥匙二档 Key switch(2P)	1NO+1NC 2NO+2NC 3NO+3NC	A16-E312 A16-E322 A16-E332		
		钥匙三档 Key switch(3P)	1NO+1NC 2NO+2NC 3NO+3NC	A16-D321 A16-D331 A16-D331		
		钥匙二档 Key switch(2P)	1NO+1NC 2NO+2NC 3NO+3NC	A16-E321 A16-E331 A16-E331		

YIEDEA TECHNOLOGY

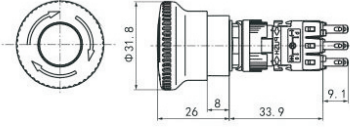
Push button & Indicator

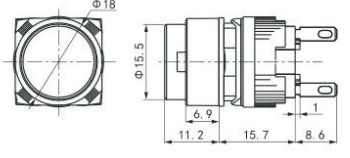
▶▶ A16 Series

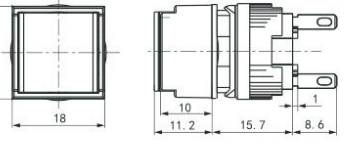
名称 / 外观 Product appearance	操作类别 Operation	带灯形式 Led form	触点 Contact	产品型号 Model	灯罩颜色 Top Color	外形尺寸 Overall dimension
急停按钮 Emergency stop 	按下锁住 旋转复位 Push to lock turn to reset	不带灯 Without LED	1NO+1NC	A16-F11R	●: 灯罩颜色 Lampshade color ■: 红色 Red	
			2NO+2NC	A16-F12R		
			3NO+3NC	A16-F13R		
		带灯 With LED	1NO+1NC	A16-FL11R		
			2NO+2NC	A16-FL12R		
			3NO+3NC	A16-FL13R		
急停按钮带警示板 Emergency stop with label 	按下锁住 旋转复位 Push to lock turn to reset	不带灯 Without LED	1NO+1NC	A16-F41R	●: 灯罩颜色 Lampshade color ■: 红色 Red	
			2NO+2NC	A16-F42R		
			3NO+3NC	A16-F43R		
		带灯 With LED	1NO+1NC	A16-FL41R		
			2NO+2NC	A16-FL42R		
			3NO+3NC	A16-FL43R		

名称 / 外观 Product appearance	操作类别 Operation	带灯形式 Led form	触点 Contact	产品型号 Model	灯罩颜色 Top Color	外形尺寸 Overall dimension
圆形 Circular 	指示灯 Indicator lamp	带灯 With LED	0NO+0NC	A16-H10 ●	●: 灯罩颜色 Lampshade color	
方形 Square 	指示灯 Indicator lamp	带灯 With LED	0NO+0NC	A16-H20 ●	●: 灯罩颜色 Lampshade color ■: 红色 Red ■: 绿色 Green ■: 黄色 Yellow ■: 白色 White	
矩形 Rectangular 	指示灯 Indicator lamp	带灯 With LED	0NO+0NC	A16-H30 ●	■: 蓝色 Blue ■: 橙色 Orange	